



Portable Power Analyzer

SPA4000



Highest Measurement Accuracy: $\pm(0.03\%$ of reading + 0.05% of range)

Sampling Rate: 2MS/s

4 Power Channels + 2 Motor Channels

Various Plug-and-Play Capability Modules for Multiple Input Ranges and Accuracies

Simultaneous and Independent Analysis of 4-harmonic channels

Instantaneous power measurement

Expandability with Voltage Output Type Current Clamp or Current Output Type Sensor

Sensor Power Supply Output for Current Phase Compensation Function

Performing Playback and Analysis

Mass Storage 512GB(1TB Optional)



SUITA ELECTRIC Corporation, headquartered in Suita, Osaka, Japan, is a leading provider of high-end equipment with a focus on quality and innovation. Drawing from years of dedicated research and development, our company delivers top-notch products that span various industries, including electric power, energy resources, transportation, automobiles, and telecommunications. Our advanced, reliable, and comprehensive test and measurement solutions are sought after by R&D companies and manufacturers. Through systematic approaches, we address the intricate demands of our customers, actively contributing to the continuous development and updating of global industries.

SPA4000 power analyzer can be used to measure various parameters such as voltage, current, power and efficiency of power conversion devices including frequency converters, motors and transformers. The instrument provides up to 4 power input units and 2 motor input channels, and supports multiple types of power module combinations. The diversity of its measuring range and accuracy makes it widely used in various industries, such as electric vehicles, new energy, frequency converters, motors, batteries, lighting, household appliances and avionics industries. The instrument has powerful functions, such as multi-channel input, high-speed sampling, real-time numeric display, waveform display, trend chart, bar chart and vector diagram, etc. It can perform efficient measurement and analysis on various systems by using its functions such as harmonic analysis, motor evaluation, voltage fluctuation and flicker measurement and FFT (Fast Fourier Transform).



Functional Advantages and Features

Various Types of Input Modules

SPA4000 supports modules with different voltages, current input ranges and accuracies. Up to 4 modules can be installed on one instrument, and they can be of different specifications. In this way, users can select modules of different specifications according to their different needs, customize the required instruments, and achieve multiple applications with only one power analyzer. At present, two modules of different specifications are available, and new modules are being updated successively.

Sensor Power Supply

The power module of SPA4000 has a sensor power supply interface. When the sensor selected by users needs power supply, it can be directly powered by this port. The traditional method of requiring external power supply device for sensors is abandoned, and excellent improvement in technology make it more convenient and efficient for users to use.

User-friendly GUI

SPA4000 adopts a 12.1-inch high-resolution touch screen that supports touch operation. The graphic function module design is convenient for users to operate intuitively. At the same time, it also supports operation by keys, knobs and mouse. Enter the channel configuration parameter list with one key, and multiple configuration parameters are displayed on the same screen, so that users can view and set relevant parameters simultaneously, and enter relevant parameter settings more conveniently.



Powerful Display Function

Multiple types of display can be achieved, including numerical value, waveform, bar chart, trend, vector, etc. More information can also be displayed in the same interface through high-definition large display screen, and various information such as numerical value, waveform, bar chart and trend can be displayed simultaneously in one interface.



Fast Switching Automatic Range

Traditional range switching is gradual, and it takes time to switch to the appropriate range. If the input signal changes significantly, it will take a long time to switch to the appropriate range, and the data during this period cannot be measured, resulting in the loss of measured data.

When SPA4000 is in automatic range and the input signal exceeds the current range, it will first switch to the maximum range, and then directly switch to the most suitable range based on the measured value, which can greatly shorten the time for range switching under automatic range and reduce the loss of measured data.

Current Phase Compensation

With phase compensation function, SPA4000 is capable of performing phase compensation of current with a resolution of 0.01° to improve the power measurement accuracy. At the same time, the internal phase compensation function can measure the power of high frequency or low power factor more accurately.

Update Rate up to 10ms

The data update rate of SPA4000 is 10ms ~ 20s (Auto). With the fastest update rate of 10ms, it can perform high-speed operation on the basis of ensuring high accuracy, and ensure the stability of measured values through independent digital filter technology. When the automatic update rate mode is enabled, it can track the frequency signal that changes from 0.1Hz and automatically change the data update rate based on the frequency of the input signal, which is convenient for measuring the changing signal more accurately.

Cycle-by-cycle Measurement

Capable of calculating the voltage, current, power and other parameters of AC input signal in each cycle, measuring data up to 3,000 cycles, and displaying the measured values in order of cycles.



Integration Function

The integral function includes power integral, current integral, etc., which can calculate electric energy(Wh) or electric charge (Ah). At the same time, there are two modes of active power integral: electricity buy and sell: integrating positive and negative AC power to make statistics on the electric energy buy and sell by the power grid; or charging and discharging: integrating positive and negative instantaneous power to make statistics on the charging and discharging charges of the battery.

In addition, when integrating for a long time, if the input signal changes greatly, measurement error will be caused by an inappropriate range. The automatic range function can be turned on when integrating to automatically adjust the range, reducing such error effectively.

Harmonic Measurement Function

Capable of performing harmonic analysis and measurement on all 4 power channels simultaneously, and selecting different PLL sources, greatly improving the efficiency of harmonic measurement in variable frequency motor, robot, lighting and other fields. The number of harmonics measured is up to 500 times.

Dual Motor Evaluation

SPA4000 can be connected with analog or pulse output signal of torque and speed sensors to measure the motor parameters, such as speed/direction, torque, synchronous speed, mechanical power, slip, electrical angle and efficiency. The input can also be divided into two groups to measure the parameters of both motors simultaneously, which is more suitable for multi-motor applications such as electric vehicles.

Instantaneous Power Measurement

SPA4000 performs calculations between the displayed waveforms and can display the calculated waveforms. For example, by multiplying the waveforms of voltage and current, it can display instantaneous power waveform of the measuring signal and measure the numerical value.



X-Y Graph Display Function

SPA4000 performs calculations between the displayed waveforms and can display the calculated waveforms. For example, by multiplying the waveforms of voltage

and current, it can display instantaneous power waveform of the measuring signal and measure the numerical value.

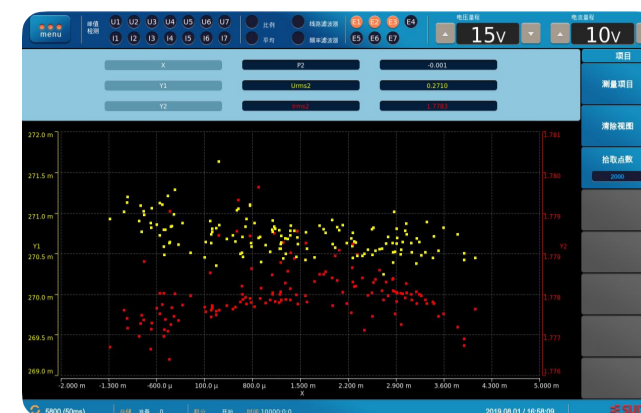

FFT Function (Fast Fourier Transform)

With FFT function, it can set parameters such as number of sampling points and sampling rate, and analyze the frequency spectrum of the input signal, so as to observe the frequency that cannot be displayed in harmonic measurement.



Logarithmic Fourier Transform display

IEC Harmonics and Voltage Flicker

IEC harmonic measurement complies with IEC61000-4-7 standard and it can measure and display current harmonic values, including inter-harmonics. It can also display voltage according to relevant IEC standards

Mass Storage and Printing

It can store voltage, current, power and other measured data as well as voltage and current display waveform data in real time, with a fastest storage rate of up to 100 times data per second. In addition, it can also save the original sampling data, which is convenient for further processing and analysis of the data in the later period. The instrument has built-in large-capacity storage space, truly achieving large-capacity and high-efficiency storage.

At the same time, an external printer can be connected through a USB or LAN port to facilitate on-site printing.

SUITA PA Viewer software

SUITA SPA4000 viewer software is a PC application software that allows users to remotely control the instrument from PC and display the numerical value, single and double harmonics, trend, vector, bar chart, combination, IEC harmonic, FFT, flicker, motor, cycle analysis, X-Y chart, low-voltage ride-through display, etc., and to save data into PC, save and print data reports of IEC harmonics and flicker.

Product Overview

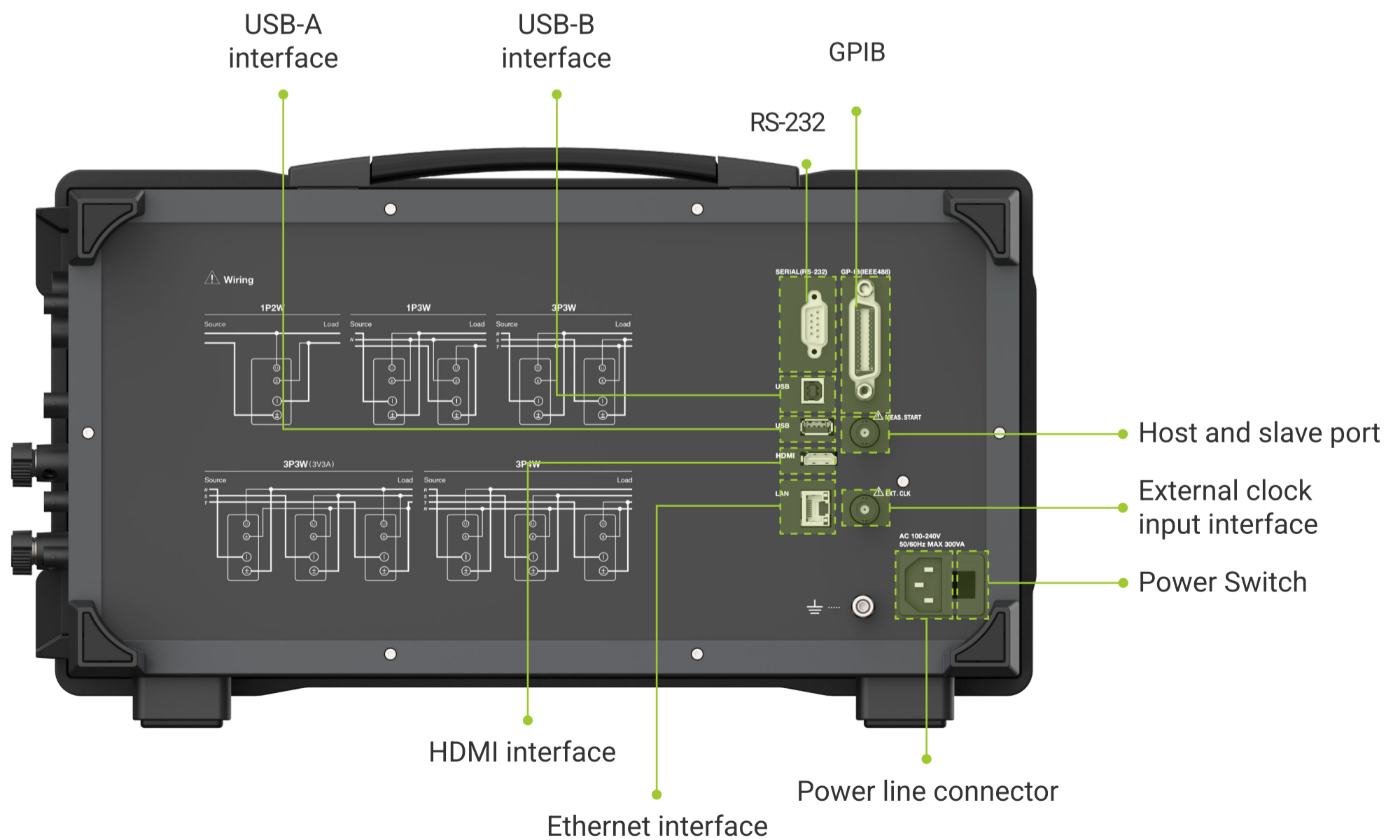
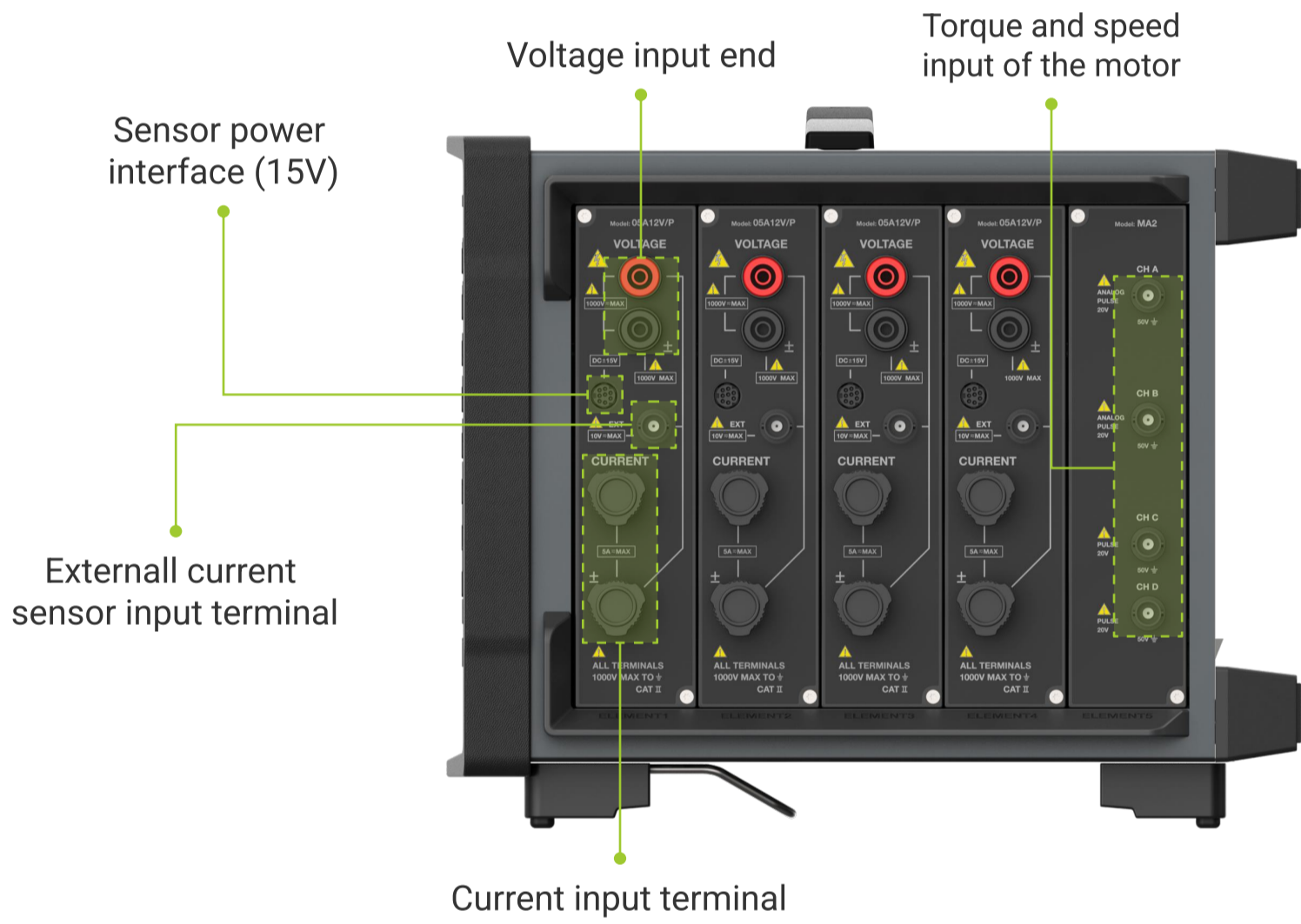

Applications

Evaluation of hybrid electric vehicles, frequency converters, and variable frequency motors

SPAW4000 provides 7 power measuring units and 2 motor measuring channels, which can measure and evaluate the voltage, current, power and efficiency of the controller (frequency converter), charger, battery and motor of electric vehicles conveniently. Two motor channels can measure the power and efficiency of both the drive motor and the generator motor simultaneously. At the same time, with v integral function, it can evaluate the charging and discharging of the battery.

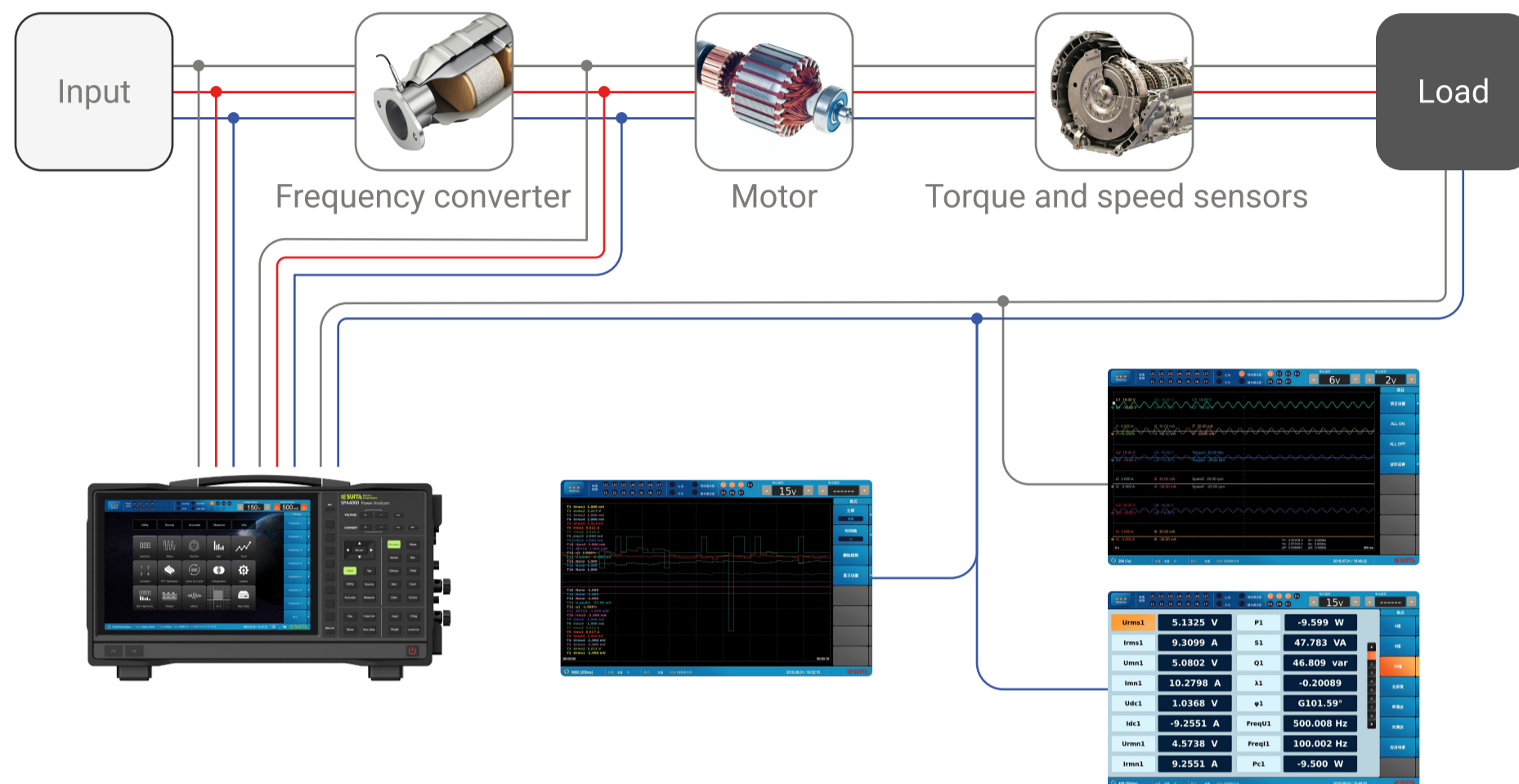

Energy efficiency conversion of new energy

As new energy power generation becomes more and more popular, the quality problems of electric energy are increasingly prominent. By using a power analyzer, the quality problems of electric energy such as harmonics and low voltage in new energy power generation can be effectively monitored and evaluated, and the efficiency and loss of each part can be measured. SPAW4000 provides 7 power measurement units, which can measure and analyze the voltage, current, efficiency and harmonics of each node. With integral function, it can evaluate and analyze the electricity buying and selling of the system or the charging and discharging of the battery.

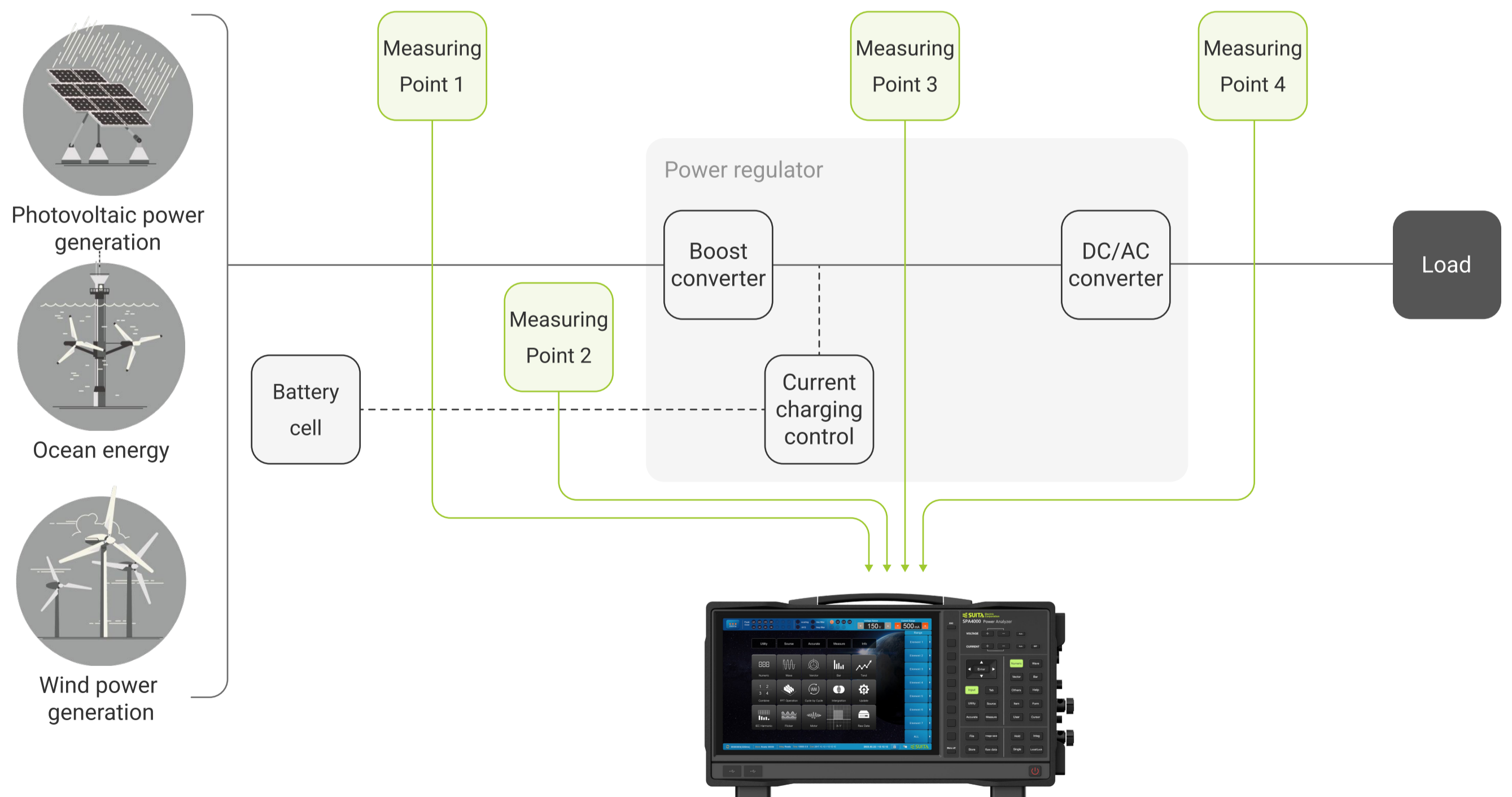

Home appliance performance testing

Household appliances are generally single-phase equipment. One SPAW4000 power analyzer can complete the measurement work of up to 7 single-phase power analyzers, measuring the voltage, current, power, frequency, power factor and harmonics, etc. By utilizing IEC harmonic and fluctuation and flicker functions, it can also perform relevant measurement and evaluation of IEC standard.



Measurement of aircraft power system

The frequency of aviation AC power supply system is generally 400Hz or 800Hz, and it is difficult for general power analyzers to meet the measurement needs in this field, especially for harmonic measurement. SPAW4000 power analyzer has a sampling rate up to 2Ms/s. When the fundamental wave is 40Hz, it can measure 500 times of harmonics, which can well meet the measurement needs.



Performance evaluation and testing of industrial robots

The core components of an industrial robot include servo motor, reducer and controller. During the operation of the robot, motion with multiple degrees of freedom is achieved through driving of the servo motor, stable output of large torque is achieved through the reducer, and synchronous control of multi-axis drive is achieved through the controller, all of which are indispensable. The industrial robot is equipped with multiple motors. To evaluate the motor-driven robot, it is necessary to measure the power consumption of all motors and controllers in various working states throughout the process. In order to analyze and learn the control process and evaluate transient characteristics of the robot, it is required to measure the transient voltage, current, power and variation trend, and be able to store the data for easy analysis.

SPAW4000 power analyzer has a sampling rate up to 2MHz. With waveform operation function, the instantaneous power can be measured, with a large-capacity memory of 512G/1T. At the same time, harmonic analysis of different PLL sources in 7 channels can be performed, and two motors can be measured simultaneously. When two SPAW4000 power analyzers are synchronized, the mechanical output parameters of 4 motors can be measured simultaneously, which is especially suitable for the performance evaluation and testing of the robot.

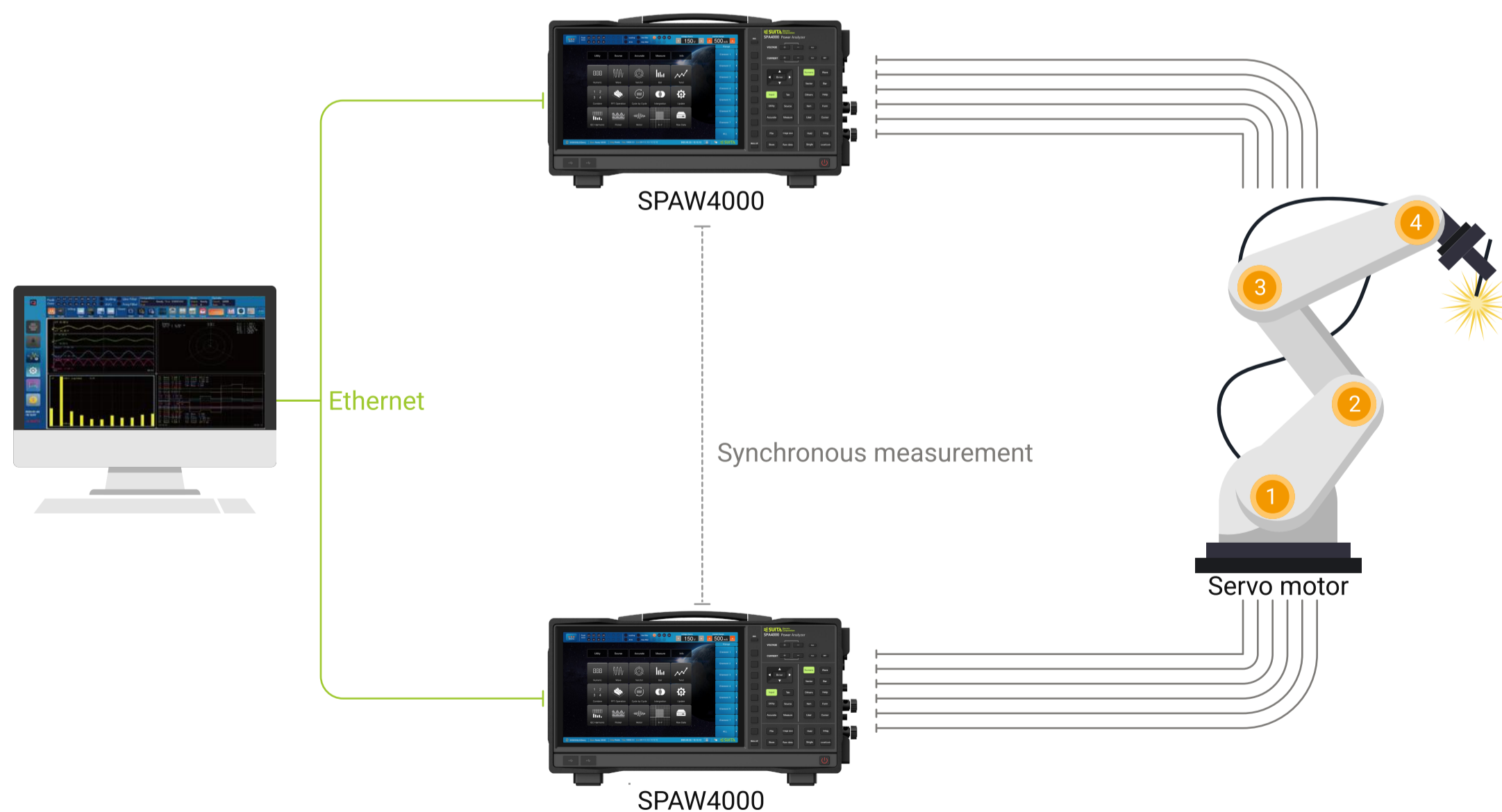

Technical Specifications

Signal Input

Item	Specifications
Type of Input Terminal	<p>Voltage: Plug-in terminal (safety terminal) Current: Outside the binding post Current sensor: Insulated BNC interface</p>
Input Type	<p>Voltage: Floating input, resistor voltage division mode Current: Floating input, shunt input mode</p>
Measurement Range (Voltage)	<p>05A35V/50A35V: 3V, 6V, 10V, 15V, 30V, 60V, 100V, 150V, 300V, 600V, 1000V (peak factor 3), 1500V (peak factor 2) 1.5V, 3V, 5V, 7.5V, 15V, 30V, 75V, 50V, 150V, 300V, 500V peak factor 6), 750V (peak factor 4)</p>
Measurement Range (Current)	<ul style="list-style-type: none"> • Direct input <p>05A35V: 10mA, 20mA, 50mA, 100mA, 200mA, 500mA 1A, 2A, 5A (peak factor3) 5mA, 10mA, 25mA, 50mA, 100mA, 250mA, 500mA, 1A, 2.5A (peak factor 6)</p> <p>50A35V: 1A ,2A, 5A, 10A, 20A, 50A (peak factor 3) 500mA, 1A, 2.5A, 5A, 10A, 25A (peak factor 6)</p> <ul style="list-style-type: none"> • External current sensor <p>50mV, 100mV, 200mV, 500mV, 1V, 2V, 2.5V, 5V, 10V (peak factor 3) 25mV, 50mV, 100mV, 250mV, 500mv, 1V, 2.5V, 5V (peak factor 6)</p>
Input Impedance	<p>Voltage 05A35V/50A35V: Input resistance is about 2MΩ, and input capacitance is about 15pF (in parallel with the resistor)</p> <p>Voltage:</p> <ul style="list-style-type: none"> • Direct input <p>05A35V: In case of 2mA~10mA, input resistance is about 10Ω (inductance effect is not obvious) In case of 20mA~200mA, input resistance is about 1Ω, and input inductance is about 0.28μH (in series with the resistor) In case of 0.5A~5A, input resistance is about 60mΩ, and input inductance is about 0.25μH (in series with the resistor)</p> <p>50A35V: In case of 100mA~1A, input resistance is about 110mΩ, and input inductance is about 0.1μH (in series with the resistor) In case of 2A~10A, input resistance is about 8.5mΩ, and input inductance is about 0.1μH (in series with the resistor) In case of 20A~40A, input resistance is about 3mΩ, and input inductance is about 0.1μH (in series with the resistor)</p> <ul style="list-style-type: none"> • External current sensor <p>Input resistance is about 1mΩ</p>
Instantaneous Continuous Maximum Allowable Input Value	<p>Voltage: 05A35V/50A35V: Take the smaller value between the peak value of 3kV and the voltage effective value of 1.65kV; Current</p> <p>Current</p> <ul style="list-style-type: none"> • Direct input <p>05A35V: In case of 2mA-10mA, take the smaller value between the peak value of 0.2A and the current effective value of 0.1A In case of 20mA-200mA, take the smaller value between the peak value of 6A and the current effective value of 2.5A In case of 0.5A-5A, take the smaller value between the peak value of 20A and the current effective value of 12A</p> <p>50A35V: In case of 1100mA~1A, take the smaller value between the peak value of 8A and the effective value of 4A In case of 2A-10A, take the smaller value between the peak value of 80A and the current effective value of 40A In case of 20A-40/50A, take the smaller value between the peak value of 100A and the current effective value of 55A</p> <ul style="list-style-type: none"> • External current sensor <p>The peak value shall not exceed 5 times the rated range</p>
Rated Voltage to Ground	<p>Voltage input terminal: CATII 1000V Current input terminal: CATII 1000V External current sensor input terminal: CATII 1000V</p>
A/D Converter	<p>Voltage and current input are converted simultaneously Resolution: 16 bits Conversion rate (sampling rate): 10μs</p>

Automatic Range Function

Resolution:

- Urms or Irms exceeds 110% of the currently set range
 - The Upk or Ipk value of input signal exceeds 330% of the currently set range (660% when the peak factor is 6)
- Range downshift (meet all the following conditions)

Resolution:

- Urms or Irms is less than or equal to 30% of the measuring range
- The Upk or Ipk value of input signal is less than 300% of the lower range (less than 600% when the peak factor is 6)

Sensor Power Supply	Interface type: Mini DIN 8Pin Output voltage: ±15V DC Maximum output power: 15W
---------------------	--

Technical Specifications of Input Module

Input Module	Range	Bandwidth (voltage/current)	Sampling Rate	Power Accuracy: ±(% of reading + % of range)
05A35V	Voltage: 3~1500V Current: 10m~5A	DC, 0.1Hz~5MHz	2MHz	0.03+0.05
50A35V	Voltage: 3~1500V Current: 10m~5A	DC, 0.1Hz~5MHz	2MHz	0.03+0.05

Measurement Conditions

Item	Specifications
Crest Factor	3 or 6
Measurement Period	Measurement period and calculation period are determined by the zero-cross point of sync source signal (when sync source is none, measurement period will be data update period); when measuring harmonics, the measurement period starts from the starting point of the update interval and ends when 1024 or 10240 points are sampled.
Sync Source	U1~U4, I1~I4, EXT CLK, None
Wiring Mode	1P2W, 1P3W, 3P3W, 3V3A, 3P4w The number of available wiring modes depends on the number of input units installed
Line Filter	OFF, 0.1kHz-100kHz (increment is 0.1kHz) 300kHz, 1MHz
Frequency Filter	OFF, 100Hz, 1kHz
Scale Factor	When inputting the output from external sensor, VT or CT, the conversion ratio, VT ratio, CT ratio and power coefficient of the current sensor can be set. The setting range is 0.0001 ~ -99999.9999
Accuracy Compensation	Efficiency compensation: Compensation for power loss caused by the instrument in efficiency operation Wiring compensation: Compensation for power loss caused by different wiring Two-wattmeter method compensation: Compensation for power loss caused by leakage current
Average Function Operation	Exponential average: Select the attenuation constant from 2~64 Linear average: Select the average number from 8~64 Harmonic measurement can only be exponentially averaged
Data Update Rate	10ms, 50ms, 100ms, 200ms, 500ms, 1s, 2s, 5s, 10s, 20s, Auto
Peak Hold	Hold the peak data(The displayed data will not be updated)
NULL Function	Purpose: To compensate DC offset Compensation object: <ul style="list-style-type: none"> • Voltage and current of each input unit (U1~U4, I1~I4) • Speed and torque
Zero Setting	Purpose: To improve the accuracy of instrument measurement Mode: Manual, automatic It will perform automatic zero setting after initialization and manual range change

Measurement Accuracy

Conditions: temperature: $23\pm 5^{\circ}\text{C}$; humidity: 30~75%RH; input waveform: sine wave; power factor (λ): 1; common mode voltage: 0V; peak factor: 3; line filter: OFF; frequency filter: ON. After preheating for 30 minutes, perform zero setting before testing. F is frequency in kHz; within six months after calibration.

05A35V / 50A35V Modules

Indicator: $\pm(\% \text{ of reading} + \% \text{ of range})$

Frequency Range of Input Signal	Voltage	Current	Power
DC	0.03+0.05	0.03+0.05	0.03+0.05
0.1Hz≤f<30Hz	0.05+0.05	0.05+0.05	0.08+0.1
30Hz≤f<45Hz	0.05+0.05	0.05+0.05	0.08+0.1
45Hz≤f<66Hz	0.03+0.05	0.03+0.05	0.03+0.05
66Hz≤f<1kHz	0.05+0.05	0.05+0.05	0.1+0.05
1kHz≤f<10kHz	0.1+0.08	0.1+0.08	0.2+0.1
10kHz≤f<50kHz	0.3+0.2	0.3+0.2	0.4+0.3
50kHz≤f<100kHz	0.012*f+0.2	0.012*f+0.2	0.014*f+0.3
100kHz≤f<500kHz	0.01*f+0.5	0.01*f+0.5	0.014*f+0.5
500kHz≤f≤1MHz	(0.024*f-7)+1	(0.024*f-7)+1	(0.048*f-17)+1

Display Function

Item	Specifications
Display	12.1-inch TFT color LCD display screen
Screen Resolution	1280 (horizontal) * 800 (vertical)
Type of Display	Numerical value, waveform, vector, bar chart, trend, combination, X-Y display
Touch Screen	Touch screen operation is supported

Numeric Value Display

Item	Specifications
Resolution of Numeric Display	6 digits, 5 digits
Display Format	4 values, 8 values, 16 values, all values, single harmonic, biharmonic, application scenarios
Display Item	All measuring functions that the instrument can achieve

Vector Display

Item	Specifications
Display Format	Single screen, double split screen
U/I Scaling Range	0.1~100
Display Item	Units 1~4, ΣA , ΣB , ΣC voltage, current fundamental effective value and phase difference vector relation

Waveform Operation

Items	Specifications
Display Format	Math1, Math2
Operational Waveform	U1~U4 waveform, I1~I4 waveform, torque waveform, and speed waveform
Operators	<p>Four arithmetic operations: (+),(-),(*),(/)</p> <p>Absolute value(ABS) Square(SQR) Square root(SQRT) Natural logarithm(LN)</p> <p>Common logarithm(LOG10) Exponent(EXP) Negative (NEG) Average(AVG2, AVG 4, AVG 8, AVG 16, AVG 32, AVG 64)</p>
Constant	K1~K8

Harmonic Measurement Function

Item	Specifications
Measuring Object	All installed units
Method	PLL synchronization method
PLL Source	U1~U4, I1~I4, EXT CLK
Frequency Range	Fundamental frequency range is 0.5Hz~99.9kHz

	Fundamental frequency	Window width	U, I, P, φ, φU, φI	Other measured values
Upper Limits of Sampling Rate, Window Width and Number of Measurements	0.5Hz - 40Hz	1	500	500
	40Hz - 440Hz	2	500	500
	440Hz - 1.1kHz	10	500	500
	1.1kHz - 2.6kHz	25	300	300
	4.8kHz - 10.5kHz	50	200	200
	2.6kHz - 4.8kHz	50	100	100
	4.8kHz - 9kHz	50	50	50
	20kHz - 50kHz	50	20	20
	50kHz - 99.9kHz	50	10	10

	Frequency	Voltage/current Power	Voltage/current Power
Accuracy of Harmonic Measurement (Indicator: ±% of reading + % of range)	0.5Hz ≤ f < 30Hz	0.01 + 0.02	0.02 + 0.05
	30Hz ≤ f < 45Hz	0.01 + 0.02	0.02 + 0.05
	45Hz ≤ f < 66Hz	0.01 + 0.02	0.02 + 0.05
	66Hz ≤ f < 1kHz	0.01 + 0.02	0.02 + 0.05
	1kHz ≤ f < 10kHz	0.01 + 0.02	0.02 + 0.05
	10kHz ≤ f < 50kHz	0.05 + 0.08	0.1 + 0.2
	50kHz ≤ f < 100kHz	0.1 + 0.15	0.2 + 0.3
	100kHz ≤ f < 500kHz	0.1 + 0.3	0.1 + 1
	500kHz ≤ f ≤ 1MHz	0.4 + 1.5	0.5 + 3.5

Cycle-by-Cycle Measurement Function

Item	Specifications
Measured Item	<p>Power unit: Urms, Irms (effective value) Urmn, Irmn (average rectified value) Umn, Imn (average rectified value calibrated to true effective value) Udc, Idc (DC value, simple mean) Uac, Iac (AC value) U+Peak, U-Peak, I+Peak, I-Peak (peak value) CfU, CfI (peak factor) P (active power) Q (reactive power) S (apparent power) Phi (power factor) λ (power-factor angle) Pc (corrected power) Motor unit: Speed 1 (speed 1), Torque 1 (torque 1), Pm1 (mechanical power 1) Frequency of synchronous source: Freq (frequency)</p>
Sync Source	U1~U4, I1~I4, EXT CLK
Sync Source Frequency Range	0.1Hz~1kHz(EXT CLK) 1Hz~1kHz (U1~U4, I1~I4)
Cycle counts	10~3000
Time-out Time	0~3,600s (time-out period is 24h when "0" is selected)

Cursor Measurement Function

Item	Specification
Cursor Type	C1+, C2x
Cursor Applications	Waveform, tendency, bar graph or FFT calculation
Cursor Measurement Display Items	Waveform: Y+, Yx, ΔY, X+, Xx, ΔX Tendency: Y+, Yx, ΔY, X+, Xx, ΔX, D+, Dx Bar graph: Y+, Yx, ΔY, X+Order, XxOrder FFT calculation: Y+, Yx, ΔY, X+, Xx, ΔX

Storage Function

Item	Specifications
File Naming	Date, number, custom
Save Format	ssf format, csv format
Storage Location	Internal SSD hard drive or external USB storage
Properties of Internal Hard Drive	Solid state drive, 512GB/1TB
Save Mode	Manual and automatic (save as csv format)
Category of Storage Item	Numeric value, waveform, and numeric value + waveform
Storage Times	1~9999999
Storage Interval	0s - 10,000h, 59min and 59s. When it is set to "0: 0: 0", it indicates the same as the data update interval
Maximum Storage Time	Depending on the amount of storage and storage medium

Raw Data Storage

Item	Specifications
Raw Data Storage	High-speed acquisition of raw data
Storage Time	Storage for up to 10min is supported
Data Storage Capacity	512GB/1TB
File Format	RAW format
Maximum Sampling Rate	2MS/s

Print Function

Item	Specifications
Print Mode	Manual, automatic
Automatic Print Mode	Timing, integral synchronization, event
Printer Connection Mode	LAN, USB

Communication Interfaces

Item	Specifications
USB-B Interface	USB2.0, USBTMC-USB488 Ver.1.0
Ethernet Interface	RJ-45 interface, which complies with IEEE802.3; 1000BASE-T, 100BASE-TX, 10BASE-T
RS-232 Interface	DB-9 (pin type), which complies with EIA-574 (EIA-232 (RS-232) 9-pin standard)
GP-IB Interface	Complies with IEEE standard 488-1978 (JIS C 1901-1987) and IEEE St'd 488.2-1992

Dimension of the Instrument

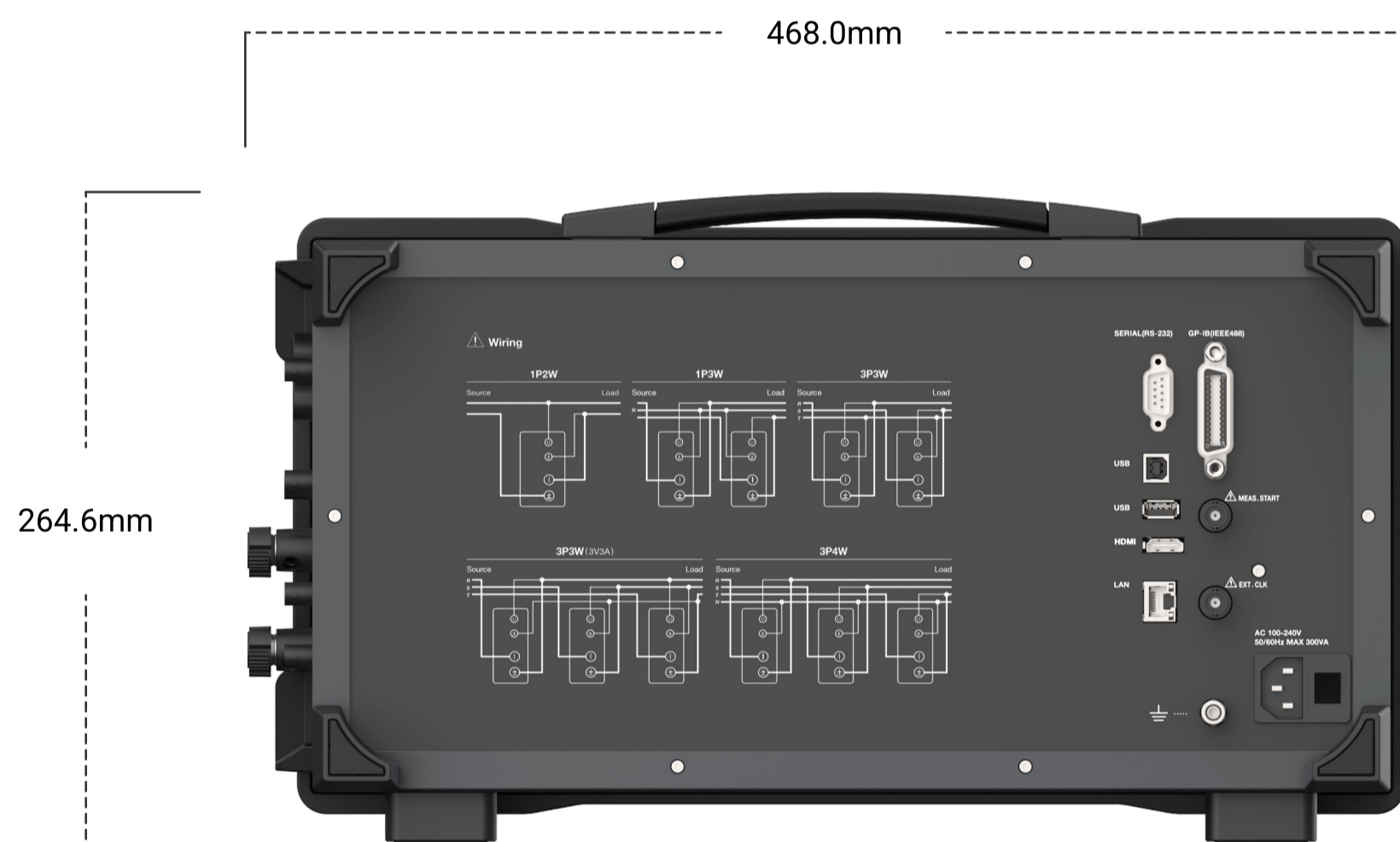

Accessories



Current Sensor of SCTH Series

	DC	AC	Accuracy	Measuring Bandwidth	Ratio KN	Resistance Rm	Aperture	Connector	Supply
SCTH60	0-60A	60Apeak	$\pm(0.05\%$ of rdg + 15 μ A)	DC-800kHz	1: 600	0-25 Ω	\varnothing 28mm	D-Sub 9 pin	\pm 12V~ \pm 15V
SCTH200	0-200A	200Apeak	$\pm(0.05\%$ of rdg + 15 μ A)	DC-500kHz	1: 1000	0-25 Ω	\varnothing 28mm	D-Sub 9 pin	\pm 12V~ \pm 15V
SCTH600	0-600A	600Apeak	$\pm(0.05\%$ of rdg + 15 μ A)	DC-300kHz	1: 1500	0-25 Ω	\varnothing 30.9mm	D-Sub 9 pin	\pm 15V~ \pm 24V
SCTH1000	0-1000A	1000Apeak	$\pm(0.05\%$ of rdg + 15 μ A)	DC-300kHz	1: 2000	0-25 Ω	\varnothing 30.9mm	D-Sub 9 pin	\pm 15V~ \pm 24V











Current Sensor of SCTX Series

	DC	AC	Accuracy	Measuring Bandwidth	Ratio KN	Resistance Rm	Aperture	Connector	Supply
SCTX60	0-60A	60Apeak	$\pm(0.01\%$ of rdg + 10 μ A)	DC-800kHz	1: 600	0-25 Ω	\varnothing 28mm	D-Sub 9 pin	\pm 12V~ \pm 15V
SCTX200	0-200A	200Apeak	$\pm(0.008\%$ of rdg + 10 μ A)	DC-500kHz	1: 1000	0-25 Ω	\varnothing 28mm	D-Sub 9 pin	\pm 12V~ \pm 15V
SCTX600	0-600A	600Apeak	$\pm(0.008\%$ of rdg + 10 μ A)	DC-300kHz	1: 1500	0-12 Ω	\varnothing 30.9mm	D-Sub 9 pin	\pm 15V~ \pm 24V
SCTX1000	0-1000A	1000Apeak	$\pm(0.008\%$ of rdg + 10 μ A)	DC-300kHz	1: 2000	0-3 Ω	\varnothing 30.9mm	D-Sub 9 pin	\pm 15V~ \pm 24V

Boxes

Model	Name	Schematic diagram	Purpose
PTB01	Test converter box of single phase connection		Used for switching for single phase circuit so that users can measure the power coefficient of the equipment quickly
PTB03	Test converter box of three-phase connection		Used for switching for single phase circuit so that users can measure the power coefficient of the equipment quickly
PTB02	External sensor connection fittings		Used for switching for single phase circuit so that users can measure the power coefficient of the equipment quickly

Connectors and Cables

Model	Name	Sample	Usage
PAC-1001	Fork terminal adapter		Used when attaching banana plug to binding post. Specification: 1000V, CAT II, 20A Color: red, black
PAC-1002	BNC Conversion adapter		Connector: Conversion between safety BNC and banana jack Specification: 600V, CAT III
PAC-1007	Small alligator adapter		Connector: safety connector Specification: 300V, CAT II, 15A Color: red, black
PAL-1001	Measurement lead		Connector: safety connector Specification: 1000V, CAT II, 32A , 600V, CAT III Color: red, black
PAL-1002	Safety BNC cable		Connector: BNC connector Specification: 1000V, CAT II, 600V, CATIII Color: black
PAL-1003	External sensor Cable		Connector: one BNC safety connector Specification: 300V, CAT II, 2A Color: black
PAC-1003	Safety adapter		Connector: Safety connector; Solder can be used for tightening the test cables. Specification: 600V, CAT II, 20A Color: red, black
PAC-1004	Safety adapter		Connector: safety connector, spring-hold type Specification: 600V, CAT II, 10A Color: red, black
PAC-1005	Safety clamp		Connector: hook shape connector Specification: 1000V, CAT III, 4A Color: red, black
PAC-1006	Large alligator adapter		Connector: safety connector Specification: 600V, CAT , 19A Color: red, black

Model and Code

Specifications	Model	Description
Main Frame	SPA4000	Power analyzer main frame (including a power cord)
Main Frame Options	/HF	IEC harmonics, flicker
	/WA	Waveform operation; X-Y display
	/MS	1TB SSD hard drive
	/IG	GP-IB
Input Module Options	05A35V	5A, 1500V, 0.03%+0.05%
	50A35V	50A, 1500V, 0.03%+0.05%
	MA2	Motor evaluation function
Additional Input Module Option	/P	Power supply for current sensor



SUITA Electric Co. Ltd

© 2017~2023 SUITA ELECTRIC CORPORATION all rights reserved

Global HQ Office: Unit 1608, 16/F, One Harbourfront,
18 Tak Fung Street, Hung Hom, Kowloon, Hong Kong

TEL: +852 2605 6955 / FAX: +852 2605 6933

Japan Office: 8-65 Higashiotabichō, Suita City, Osaka 564-0033

TEL: +81 06-6383-1700 / FAX: +81 06-6383-1701

Website: <http://suitaelectric.com>

Email: sales@suitaelectric.com